

SPME



Single Phase Compact Low-Profile Power Supply



Benefits

- **Universal AC input range.** SPME series can be powered with AC voltage (85 VAC to 264 VAC) or with DC voltage (120 VDC to 370 VDC).
- **CE and UL approvals.** These power supplies meet CE and UL62368-1.
- **Reliable power in very compact dimensions.** SPME has an ultra-slim body, from 15 W in 17.5 mm (1 DIN), up to 100 W in only 70 mm (4 DIN) of space.
- **High efficiency, long life and high reliability.** The SPME has a very high efficiency of up to 91.5% (SPME 150 W series).
- **Reliable critical output protections.** Safe operation is guaranteed by the various output protections: Over Current (OVC), Over Voltage (OVP), Short Circuit (SCP), Over Temperature (OVT) available for SPME150 series.
- **Wide operating ambient temperature.** The operating temperature range is from -40 °C to +70 °C (-40 °F to 158 °F), and a storage temperature range from -40 °C to +85 °C (-40 °F to 185 °F).

Description

SPME Modular switching power supplies are specifically designed to satisfy both the industrial automation and the building automation application requirements. The four DIN modules power supplies are capable of up to 100 W of output power. Its high efficiency prevents excess of heat in the installation place. These power supplies meet CE and UL62368-1, and the 4 kVAC isolation voltage that is mandatory for automotive battery charger applications.

All specifications are at nominal values, full load, 25°C unless otherwise stated.

Applications

The SPME is extremely suitable for automotive battery chargers, high efficiency and applications requiring wide operating ambient temperature. SPME series featuring a cost-effective, energy efficient solution for standard DIN-rail mounting. The products offer a high level of stability and immunity to noise, compliant with international IEC62368 standards for EMC and safety specifications meet UL62368. These light weight AC-DC converters also have an extremely compact design for space saving and are ideal for applications such as industrial control equipment machinery and all kinds of applications in a harsh environment.

Main functions

- Universal input voltage range: 85 VAC to 264 VAC; 120 VDC to 370 VDC
- Output options of 12 VDC or 24 VDC
- From 1 DIN to 4 DIN modules, from 15 W to 100 W
- Green LED for status indication
- Voltage output adjustment
- High efficiency up to 91.5% (SPME 150 W series)

References

Order code

 SPME 1



Enter the code entering the corresponding option instead of .

Code	Option	Description	Notes
S	-	Switching	Device typology
P	-	Power supply	
M	-	Modular	
E	-	High efficiency	Series
<input type="checkbox"/>	12	12 VDC	Rated output voltage
	24	24 VDC	
<input type="checkbox"/>	15	15 W	Rated output power
	24	24 W	
	36	36 W	
	50	54 W	
	60	60 W	
	90	90 W	
	100	100 W	
1	-	Single phase input	Input type

Selection guide

Output voltage	Output power						
	15 W	24 W	36 W	54 W	60 W	90 W	100 W
12 VDC	SPME12151	SPME12241	-	SPME12501	-	SPME12901	-
24 VDC	SPME24151	-	SPME24361	-	SPME24601	-	SPME241001

Further reading

Information	Where to find it	QR
SPME Data sheet	https://gavazziautomation.com/images/PIM/DATASHEET/ENG/SPME_DS_EN.pdf	
SPME Instruction manual	https://gavazziautomation.com/images/PIM/MANUALS/ENG/SPME_IM.pdf	

Structure

SPME 15 W

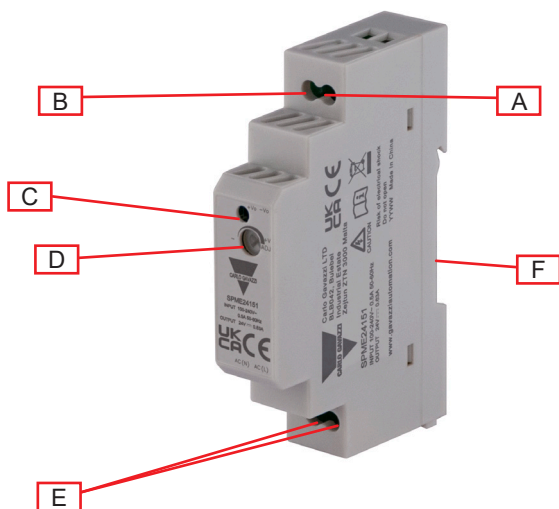

SPME 24 / 36 W

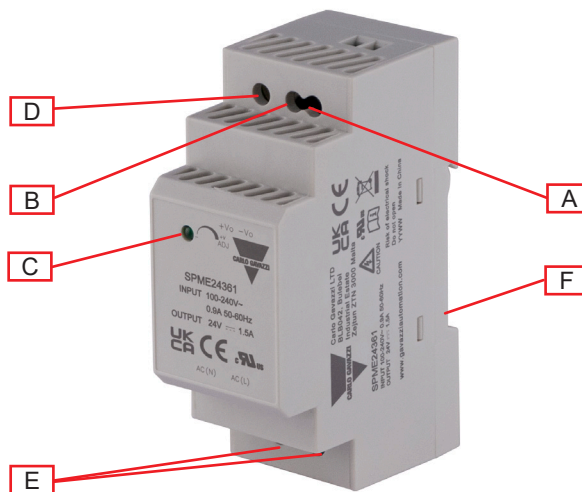

Element	Component	Function
A	- V terminal	Negative DC output terminal
B	+ V terminal	Positive DC output terminal
C	DC OK LED	Green
D	VADJ Trimmer	Output voltage adjustment
E	Power supply terminals	L, N supply terminals + GND
F	DIN rail mounting clip	Clip present on back side



SPME 54 / 60 W

SPME 90 / 100 W

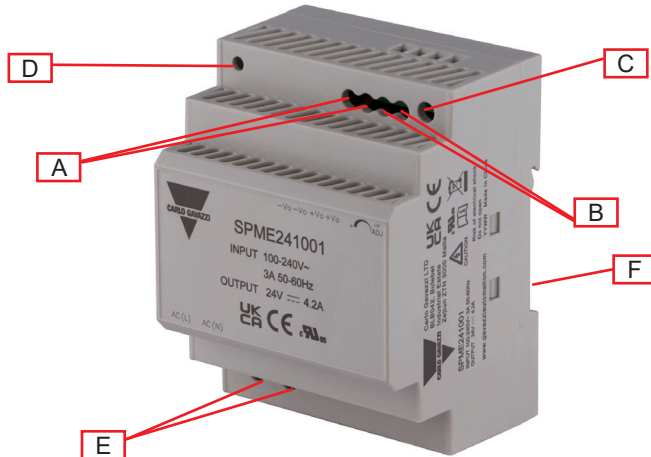
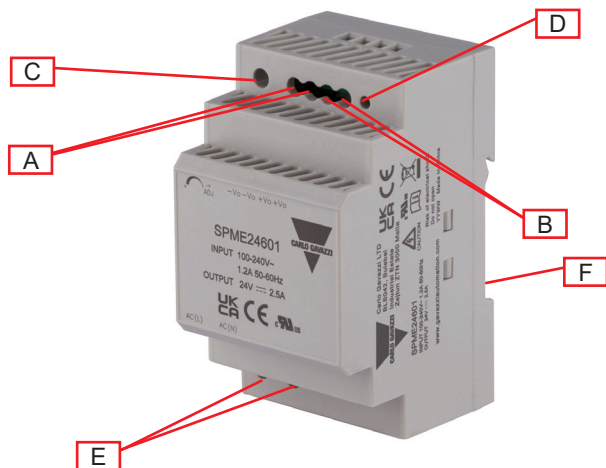

Element	Component	Function
A	- V terminals	Negative DC output terminals
B	+ V terminals	Positive DC output terminals
C	VADJ Trimmer	Output voltage adjustment
D	DC OK LED	Green
E	Power supply terminals	L, N supply terminals + GND
F	DIN rail mounting clip	Clip present on back side

Features

General data

	15 W	24 W	36 W	54 W	60 W	90 W	100 W
Leakage current	< 0.5 mA (240 VAC)	< 0.25 mA (264 VAC)		< 0.25 mA (264 VAC)		< 0.5 mA (240 VAC / 50 Hz)	
Efficiency	85 % (12 VDC) 86 % (24 VDC)	88 %			90 %	88 %	90 %
Power loss @ nominal load	2.65 (12 VDC) 2.46 (24 VDC)	3.27	4.91	7.36	6.67	12.27	11.20
Switching frequency	65 kHz						
MTBF	> 300,000 Hrs						
Case material	Plastic, heat-resistant (UL94V-0)						
Weight	60 g (0.13 lb)	115 g (0.25 lb)		175 g (0.39 lb)		235 g (0.52 lb)	
Mounting	DIN rail						

Dimensions

SPME 15 W

Unit: mm [inches]

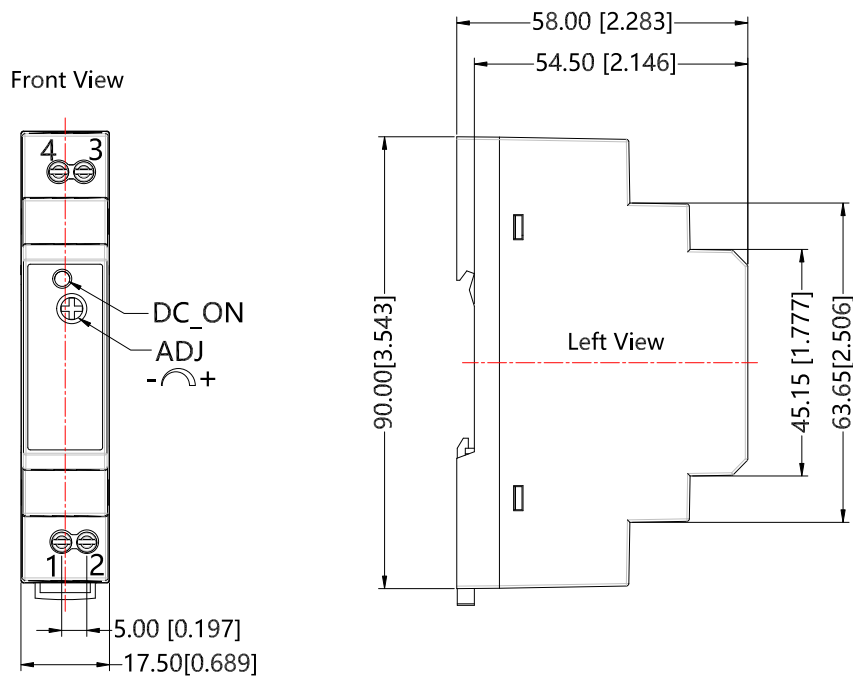

SPME 24 / 36 W

Unit: mm [inches]

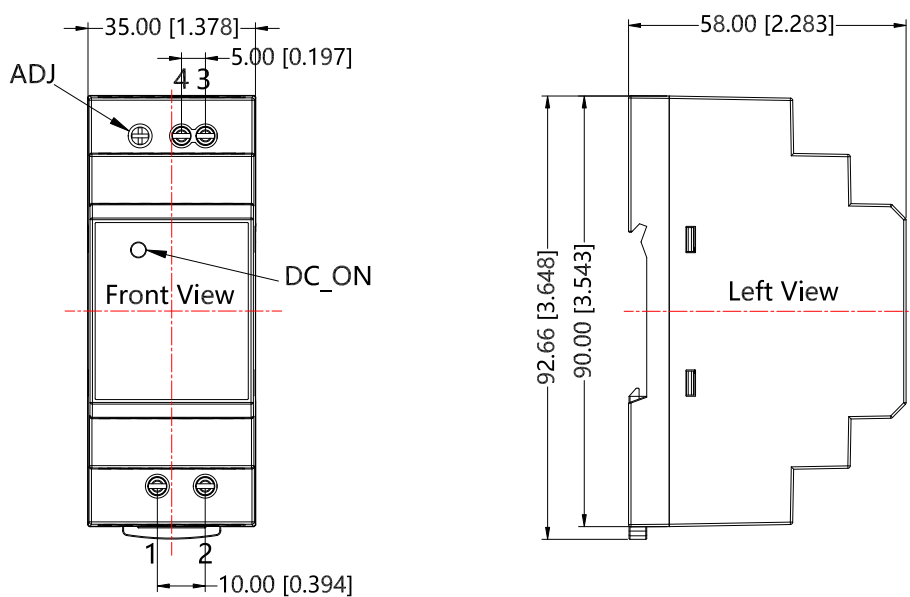

SPME 54 / 60 W
Unit: mm [inches]

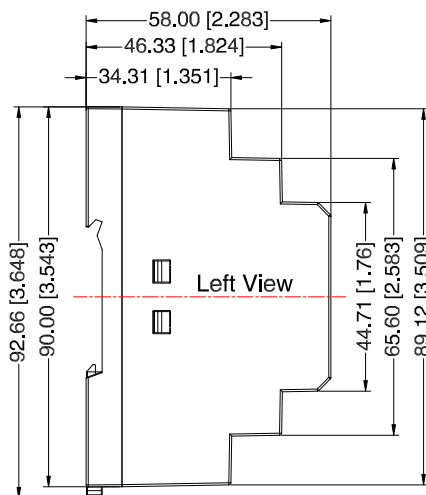
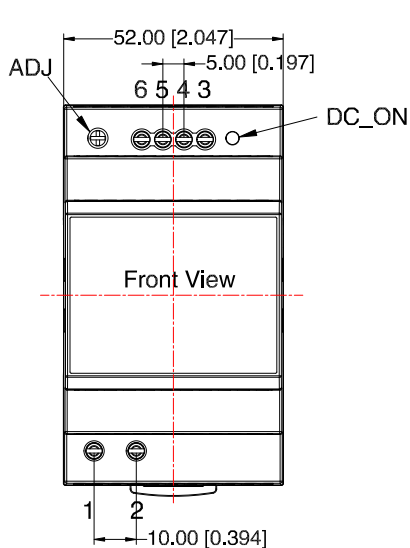

SPME 90 / 100 W
Unit: mm [inches]

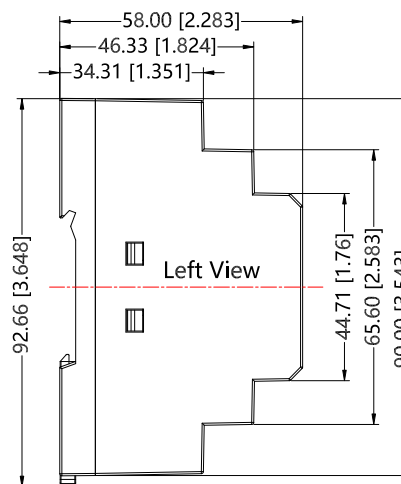
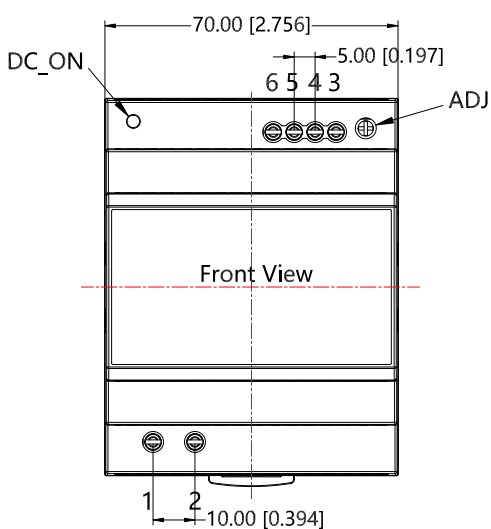

Connection diagram

Terminal markings

SPME 15 W

Terminal	Designation	Description
1	N	Input terminals (neutral conductor, no polarity with DC input)
2	L	Input terminals (phase conductor, no polarity with DC input)
3	V+	Positive output terminal
4	V-	Negative output terminal
5	Vout ADJ.	Potentiometer for output voltage adjustment
6	DC status	LED indication of power supply output status

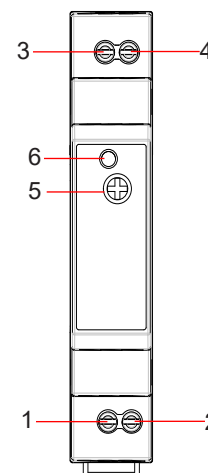

SPME 24 / 36 W

Terminal	Designation	Description
1	N	Input terminals (neutral conductor, no polarity with DC input)
2	L	Input terminals (phase conductor, no polarity with DC input)
3	V+	Positive output terminal
4	V-	Negative output terminal
5	Vout ADJ.	Potentiometer for output voltage adjustment
6	DC status	LED indication of power supply output status

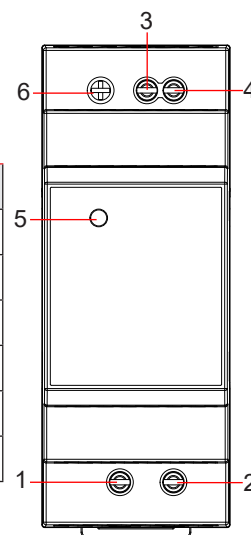

SPME 54 / 60 W

Terminal	Designation	Description
1	N	Input terminals (neutral conductor, no polarity with DC input)
2	L	Input terminals (phase conductor, no polarity with DC input)
3, 4	V+	Positive output terminal
5, 6	V-	Negative output terminal
7	Vout ADJ.	Potentiometer for output voltage adjustment
8	DC status	LED indication of power supply output status

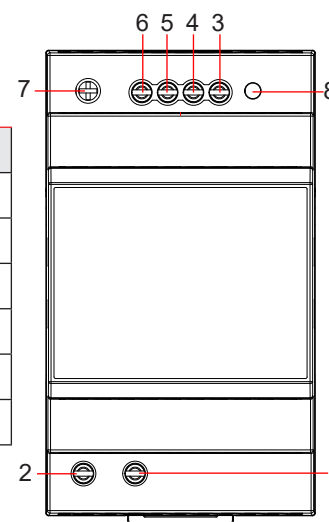

SPME 90 / 100 W

Terminal	Designation	Description
1	N	Input terminals (neutral conductor, no polarity with DC input)
2	L	Input terminals (phase conductor, no polarity with DC input)
3, 4	V+	Positive output terminal
5, 6	V-	Negative output terminal
7	Vout ADJ.	Potentiometer for output voltage adjustment
8	DC status	LED indication of power supply output status

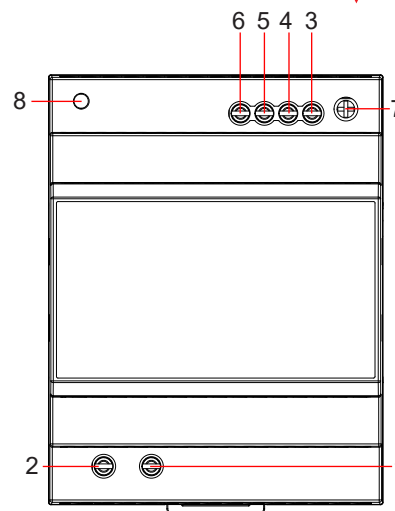

Compatibility and conformity

	15 W	24 W	36 W	54 W	60 W	90 W	100 W	
Safety standards	UL/IEC62368-1/ EN62368-1 IEC/EN61010-1 IEC/EN61558-1 EN61558-2-2 EN61558-2-16 EN61204-7 IEC60335-1 EN62368-1 EN60335 OVCII	EN61558-1 EN61558-2-2 EN61558-2-16 EN61204-7 UL62368-1/IEC62368-1 Safety Approval cURus UL62368 EN62368-1 (Report) EN60335 OVCII						
Approvals								
Conducted (CS) IEC/EN 61000-4-6	10 Vrms (PC A)							
Voltage dips IEC/EN61000-4-11	0% for 1 cycle 30% for 25 cycles (PC B)	0% (PC A)					70% (PC A)	
Voltage interruptions IEC/EN61000-4-11	100% for 250 cycles (PC B)							
EMC emission CE: CISPR32/EN55032 RE: CISPR32/EN55032	Class B Class B							
Harmonic current	IEC/EN61000-3-2 Class A	-						
EMC immunity ESD: IEC/EN 61000-4-2 RS: IEC/EN 61000-4-3 EFT: IEC/EN 61000-4-4 Surge: IEC/EN 61000-4-5	contact ± 4 kV / air ± 8 kV 10 V/m ± 2 kV line to line ±1 kV	contact ± 6 kV / air ± 8 kV 10 V/m ± 2 kV line to line ±2 kV						
Vibration resistance	10 ~ 150 Hz, 2G, period for 30 min. Each along X, Y, Z axes							
Semi F47	Tolerated sags to 50% of equipment nominal voltage for duration of up to 200 ms							

*except for SPME 15 W



Environmental

	15 W	24 W	36 W	54 W	60 W	90 W	100 W
Temperature operating range	-40 °C to 70 °C (-40 °F to 158 °F)						
Temperature storage	-40 °C to 85 °C (-40 °F to 185 °F)						
Humidity	< 95 % RH non-condensing						
Operating altitude	2000 m						
Temperature derating	Refer to derating diagram						
Temperature regulation	± 0.02 % / °C					± 0.03 % / °C	
Ventilation and cooling	Cooling by free air convection						

Insulation

Insulation / withstand voltage (I / O)	Primary - Secondary < 4 kVAC / 5 mA
Insulation resistance	≥ 100 MΩ
Overvoltage category	III
Pollution degree	PD2

Inputs

	15 W	24 W	36 W	54 W	60 W	90 W	100 W
Rated input voltage	100 VAC to 240 VAC						
Input voltage range	85 VAC to 264 VAC 120 VDC to 370 VDC						
AC current (max) 115 VAC 230 VAC	< 0.5 A < 0.25 A	< 0.9 A < 0.5 A	< 1.2 A < 0.8 A			< 3.0 A < 1.6 A	
Frequency range	47 Hz to 63 Hz						
Inrush current 115 VAC 230 VAC	< 15 A < 25 A	< 25 A < 45 A	< 30 A < 60 A			< 35 A < 70 A	
Internal input fuse (250 VAC)	2 A	3.15 A				6.3 A	
Standby power consumption	< 0.3 W	-	< 0.3 W	< 0.3 W	< 0.3 W	< 0.35 W	



Outputs

		15 W	24 W	36 W	54 W	60 W	90 W	100 W
Output power		15 W	24 W	36 W	54 W	60 W	90 W	100 W
Voltage accuracy		± 1.0 %	± 2.0 %					
Line regulation		± 0.5 %						
Load regulation		± 1.0 %	± 1.5 %					
Voltage regulation span	12 VDC	10.8 V ~ 13.8 V		-	10.8 V ~ 13.8 V	-	12.0 V ~ 13.8 V	-
	24 VDC	21.6 V ~ 29.0 V	-	21.6 V ~ 29.0 V	-	21.6 V ~ 29.0 V	-	21.6 V ~ 29.0 V
Rated output current	12 VDC	1.25 A	2 A	-	4.5 A	-	7.5 A	-
	24 VDC	0.63 A	-	1.5 A	-	2.5 A	-	4.2 A
Rated continuous loading	12 VDC	1.38 A @ 10.8 V / 1.08 A @ 13.8 V	2.22 A @ 10.8 V / 1.74 A @ 13.8 V	-	5 A @ 10.8 V / 3.91 A @ 13.8 V	-	7.5 A @ 12 V / 6.52 A @ 13.8 V	-
	24 VDC	0.7 A @ 21.6 V / 0.52 A @ 29 V	-	1.66 A @ 21.6 V / 1.24 A @ 29 V	-	2.78 A @ 21.6 V / 2.07 A @ 29 V	-	4.67 A @ 21.6 V / 3.48 A @ 29 V
Ripple and noise 20 MHz bandwidth (peak-to-peak value)	12 VDC	≤ 120 mV	≤ 120 mV		≤ 120 mV	-	≤ 120 mV	-
	24 VDC	≤ 150 mV	-	≤ 150 mV	-	≤ 150 mV	-	≤ 150 mV
Hold up time								
115 VAC		12 ms	12 ms		15 ms		-	
230 VAC		30 ms	60 ms		80 ms		30 ms	
Set-up time		2 s	3 s					
Rise time		25 ms	15 ms		25 ms		15 ms	
Turn-on overshoot		<10 % (Type: 3 %)						
Overshoot and undershoot								
Series operation		Support output series boost voltage, it is suggested 15 mm space						
Parallel operation		No						
Power boost		Support output series boost voltage						

Performance

Typical efficiency curves

SPME 15 W

Efficiency vs. Input Voltage (Full Load)

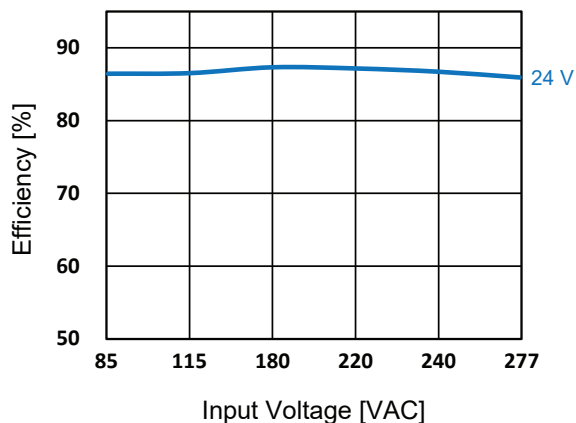

Efficiency vs. Output Load (230 VAC)

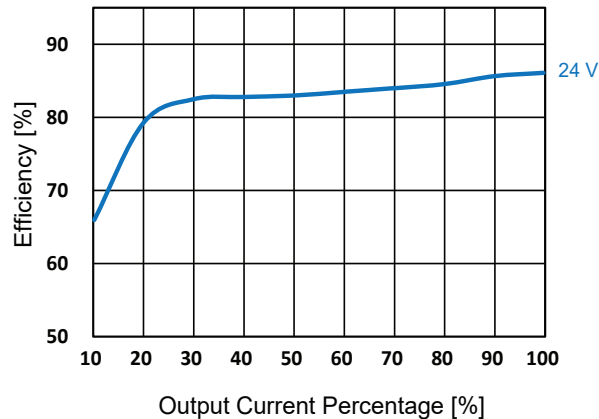

SPME 24 / 36 W

Efficiency vs. Input Voltage (Full Load)

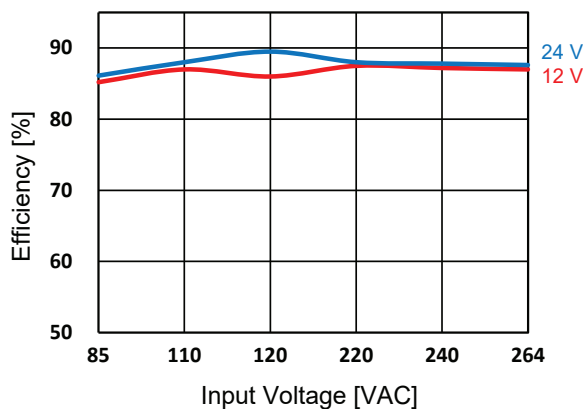

Efficiency vs. Output Load (230 VAC)

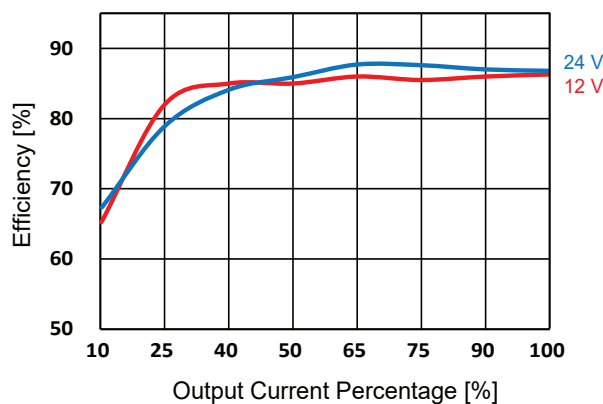

SPME 54 / 60 W

Efficiency vs. Input Voltage (Full Load)

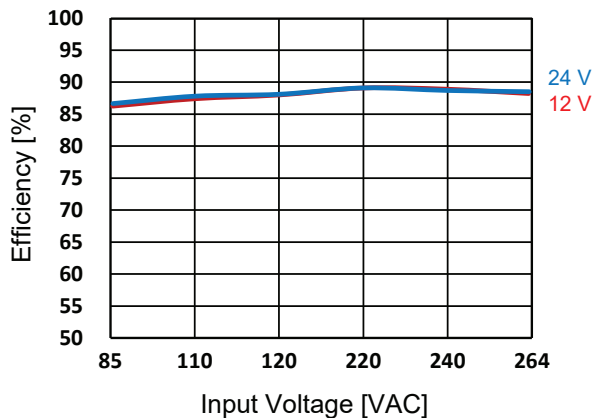

Efficiency vs. Output Load (230 VAC)

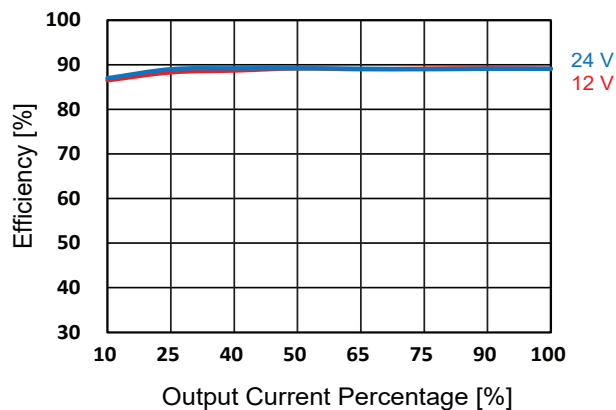

SPME 90 / 100 W

Efficiency vs. Input Voltage (Full Load)

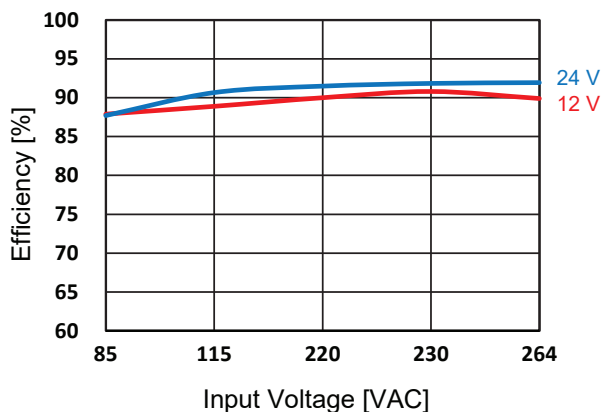

Efficiency vs. Output Load (230 VAC)

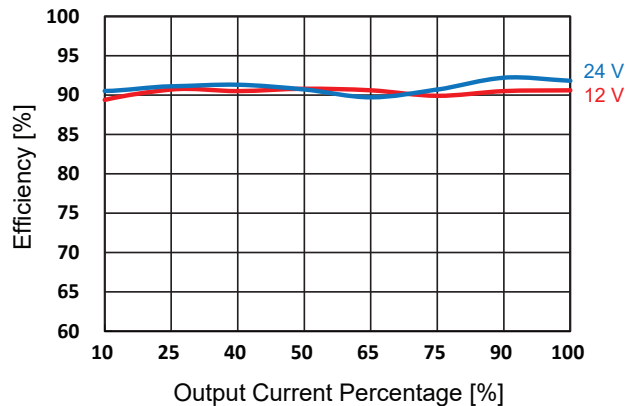

Current derating

SPME 15 W

Temperature derating curve

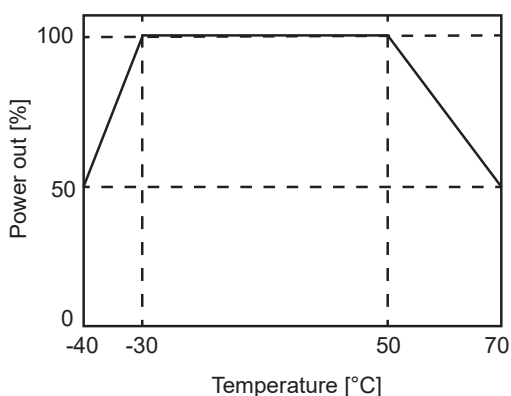

Input voltage derating curve

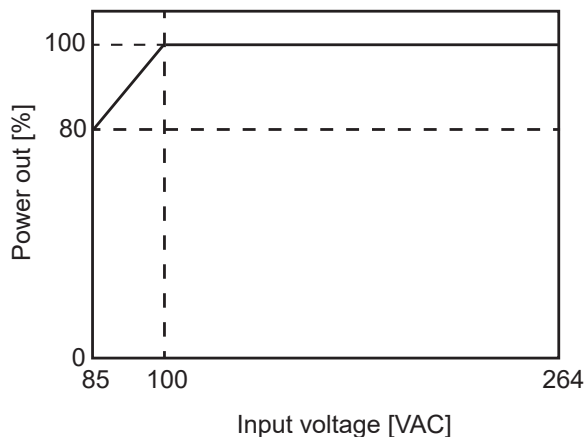

SPME 24 / 36 W

Temperature derating curve

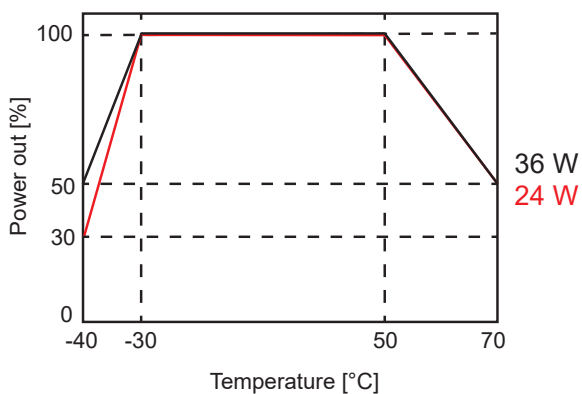

Input voltage derating curve

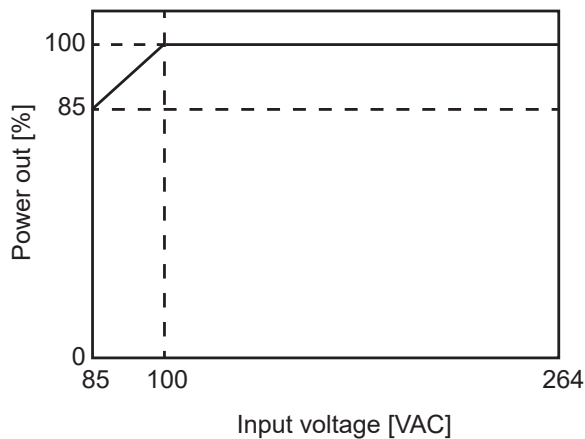

SPME 54 / 60 W

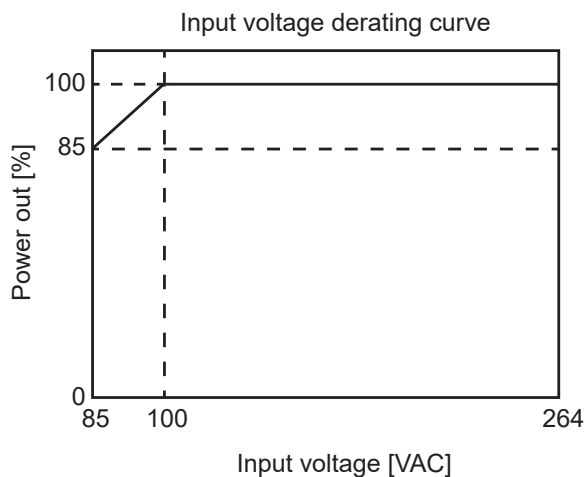
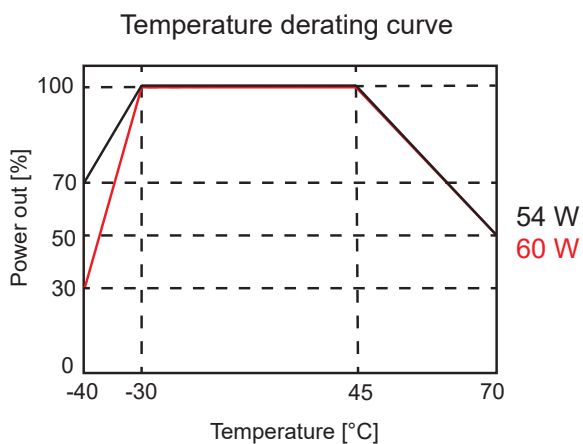

SPME 90 / 100 W

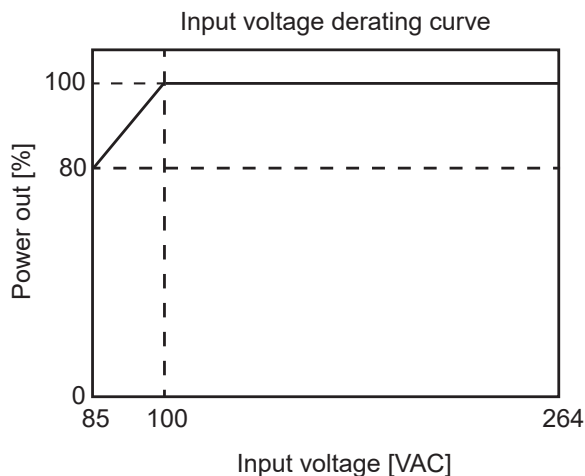
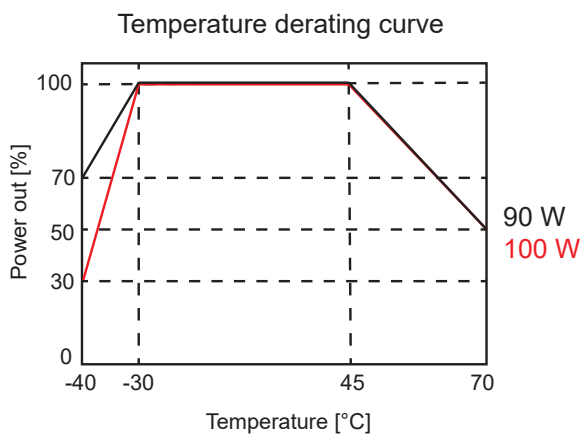

▶ **Wiring diagram**

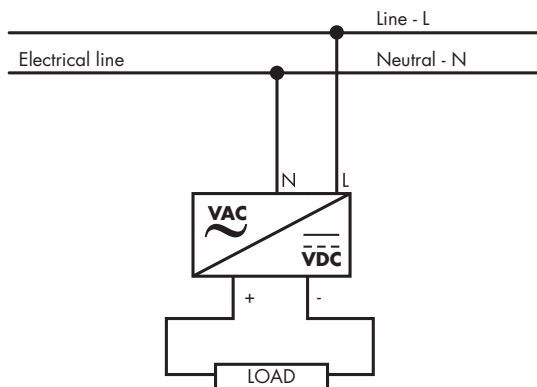

▶ **Connection specification**

		15 W	24 W	36 W	54 W	60 W	90 W	100 W
Terminal type	Input	Screw terminals						
	Output							
Screw driver blade		M3						
Tightening torque (recommended)		≤ 0.4 Nm						
Flexible conductor cross section max - min		0.25 - 4 mm ² (24 - 12 AWG)						
Conductor cross section AWG min - max								
Rigid conductor cross-section min - max								

▶ **Block diagram**

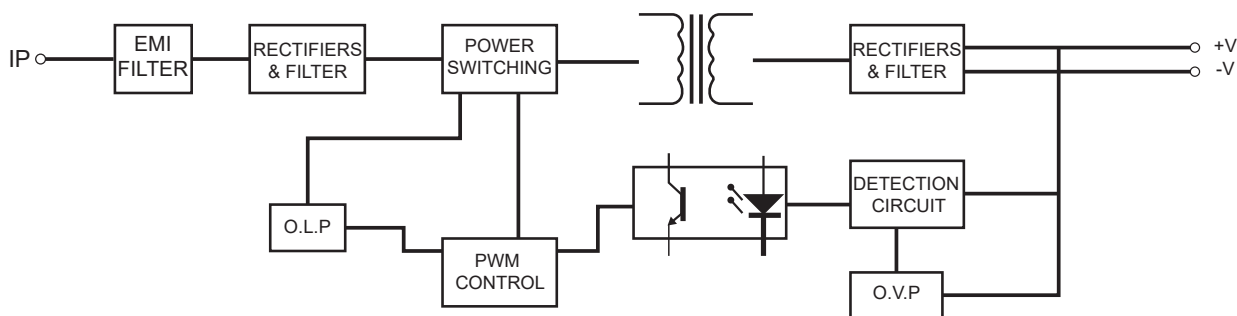

Troubleshooting

▶ Signaling and controls

DC OK LED	Yes
DC OK output type	LED (green)
Alarm threshold	When the fault occurs and the output voltage is abnormal, the light flashes or does not light up.

Operating description

▶ Control and protection

	15 W	24 W	36 W
Overvoltage protection	$\leq 16.2 \text{ V (12 VDC)}$ $\leq 36 \text{ V (24 VDC)}$	$\leq 16 \text{ V}$	$\leq 36 \text{ V}$
	Output voltage hiccup	Output voltage clamp or hiccup	
Overload protection	$\geq 110\% I_o$, self-recovery Hiccup mode or constant current limiting when output voltage < 50%, recovers automatically after fault condition is removed Constant current limiting within 50% -100% rated output voltage, recovers automatically after fault condition is removed	$\geq 120\% I_o$, self-recovery	
	Short circuit protection	Hiccup, continuous, self-recovery	

	54 W	60 W	90 W	100 W
Overvoltage protection	$\leq 16 \text{ V}$	$\leq 36 \text{ V}$	$\leq 20 \text{ V}$	$\leq 35 \text{ V}$
	Output voltage clamp or hiccup			
Overload protection	$\geq 120\% I_o$, self-recovery		110% - 200% I_o , self-recovery	
Short circuit protection	Hiccup, continuous, self-recovery			